

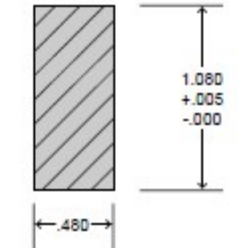

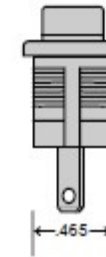

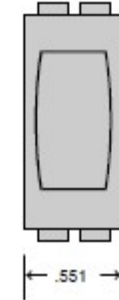

# CRSL Series Lighted Single-pole Rocker Switches

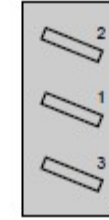
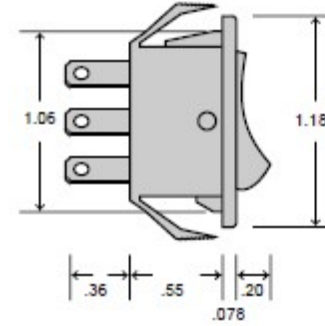

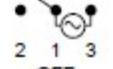
Panel Cut Out  
Panel Thickness 1/32" - 3/16"

Circuit	Switching		
1	SPST Maintained Refer to Note 1		
4	SPST (Momentary) Normally Open Refer to Note 1		
0	G		

**NOTE 1.** Furnished with one side of the lamp internally connected and a single lamp-terminal at the back of the switch.

## Approvals

UL recognized, CSA certified. Load rating: 20A 125/250 VAC, 1 HP, 125/250 VAC, 14A 14VDC, VDE approval 15A. Contacts: fine silver for long life dependability. Dielectric strength: 1250 volts (live parts to ground). Life: 35,000 operations at maximum rating. Insulation resistance: 5 megohms.

## Low Level Control

For low level/dry circuit applications (<100 am) contact factory for part number (Gold plated contacts).

## High Inrush

125 Amp inrush capability (AgNi contacts).

## Terminals

Style A - 1/4-inch quick-connect

## Mechanical Features

100,000 mechanical operations

## Lamps

6, 12 and 28 volt incandescent lamps standard. 125 and 250 volt neon lamps standard.

## Special Lamps

Green neon 125 and 250 volt lamps for green actuator.

## LED Display

LED display options available. Consult factory.

## Markings

Letters, numbers and symbols can be applied to rocker actuator or to integral nylon bezel; see inside back cover for details.

## Mounting

Snap-in type panel mounting for ease of installation without additional mounting hardware.

## Ordering Information:

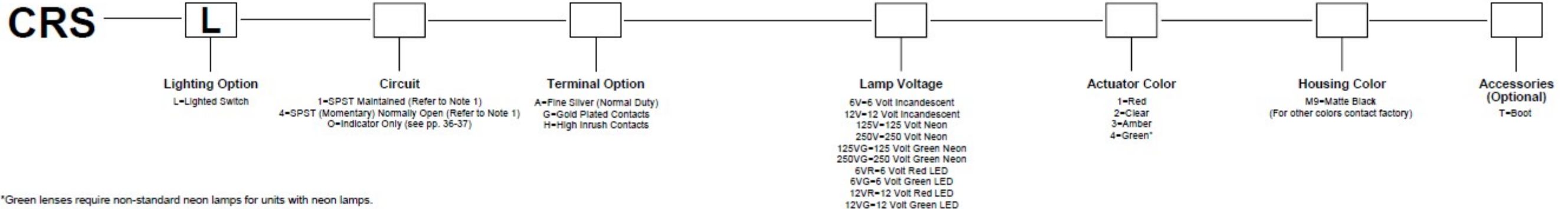

\*Green lenses require non-standard neon lamps for units with neon lamps.